

THE START FAMILY



Start



Super Start



Start Auto



Super Start Auto



RHENINGHAUS

THE START FAMILY

La nostra Azienda progetta, produce, documenta, garantisce il servizio ricambi, assicurando la Qualità.

Our Company designs produces supplies technical documentation guarantees the spare part service and assures quality.

Notre Société projette, produit, documente et garantit le service pièces détachées tout en assurant la qualité.

Unsere Firma entwerft, herstellt, versichert, belegt mit Unterlagen den Ersatzteildienst und dabei versichert die Qualität.

Nuestra empresa desarrolla, produce, dispone de folleteria y manuales, cuenta con servicio repuestos, asegurando la Calidad.

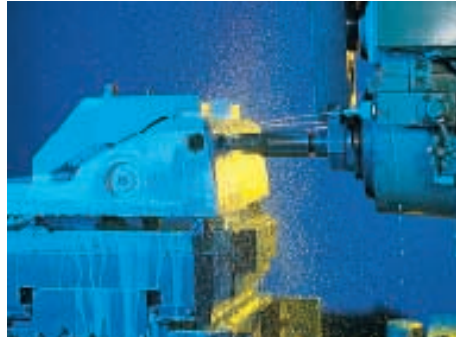

Tutti i modelli sono disponibili con marchio CE
 All models are available with CE-Mark
 Tous les models sont disponibles avec marque CE
 Alle Modellen sind mit CE-Zeichen verfügbar
 Todos los modelos estan disponibles con norma CE

SCEGLIETE IL MODELLO GIUSTO PER LE VOSTRE ESIGENZE

SELECT THE RIGHT MODEL FOR YOUR REQUIREMENTS

CHOISISSEZ LE MODÈLE APPROPRIÉ À VOS EXIGENCES

DAS RICHTIGE MODELL FÜR IHRE BEDÜRFNISSE WÄHLEN

ELIJA EL MODELO JUSTO PARA SUS EXIJIENCIAS

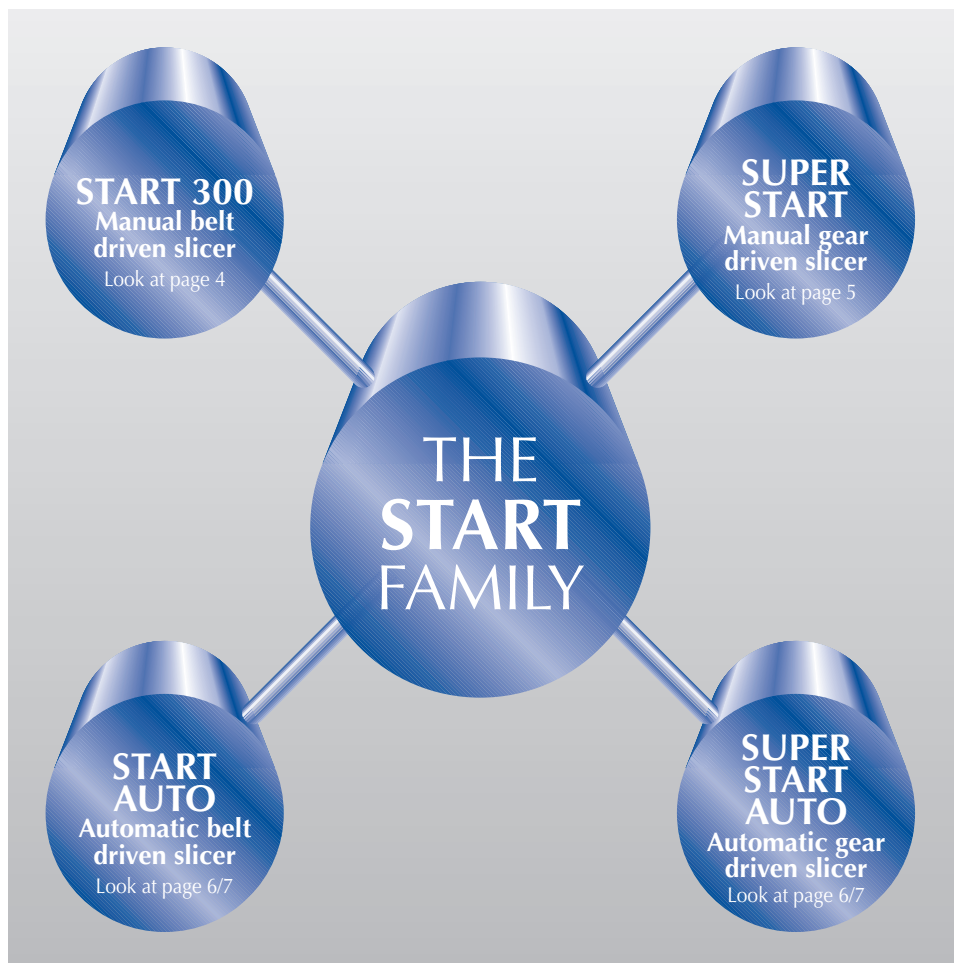

THE START FAMILY: AUTOMATIC SLICERS

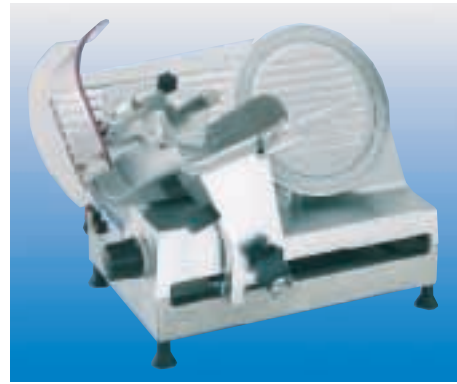

START AUTO

Start Auto è un'affettatrice automatica con trasmissione a cinghie: è indicata per grandi negozi, ristoranti, laboratori di preparazione di panini.

Start Auto is an automatic belt driven slicer suitable for large shops, restaurants and sandwich preparing laboratories

Start Auto est un trancheur automatique avec transmission par courroie indiqué pour grands magasins de boucherie et charcuterie, restaurants et laboratoires pour la préparation des sandwich.

Start Auto ist eine automatische Aufschnitt-Schneidemaschine mit Riemenantrieb geeignet für große Geschäfte, Restaurants, große Sandwich vorbereitende Labor.

Start Auto es una cortadora automática con transmisión a correa: la indicada para grandes fiabbrerías, restaurantes, sandwicherías.



SUPER START AUTO

Super Start Auto è un'affettatrice automatica con trasmissione a ingranaggi: è indicata per supermercati, grandi cucine, ristorazioni collettive

Super Start Auto is an automatic gear driven slicer suitable for supermarkets, large catering installations, large canteens

Super Start Auto est un trancheur automatique avec transmission à engrenages indiqué pour supermarchés, grandes cuisines, grandes communautés.

Super Start Auto ist eine automatische Aufschnitt-Schneidemaschine mit Zahnradantrieb geeignet für Supermärkte, große Küchen und Kantinen.

Super Start Auto es una cortadora automática con transmisión a engranajes: la indicada para supermercados, grandes cocinas, servicio de catering.



THE START FAMILY: MANUAL SLICERS

START 300



Start 300 è un'affettatrice manuale con trasmissione a cinghie: è indicata per negozi, bar, ristoranti, medie cucine.

Start 300 is a belt driven manual slicer suitable for shops, bars, restaurants medium size kitchen installations.

Start 300 est un trancheur manuel avec transmission par courroie indiqué pour magasins, bars, restaurants.

Start 300 ist eine manuelle Aufschnitt-Schneidemaschine mit Riemenantrieb geeignet für Geschäfte, Bars, Restaurants, Kantinen.

Start 300 es una cortadora manual con transmissiòn a correa: la indicada para almacenes, bares, restaurantes, cocinas medianas.



Modello con coprilama ad anello fisso
Fixed ring-guard model
Model avec couvre-lame à anneau fix
Modell mit feststehendem Messerschutzring
Modelo con cubre-cuchilla a anillo fijo



Pulizia: piatto ribaltabile e interbloccato
Safe cleaning: tiltable and interlocked platform
Nettoyage sûr: plateau basculant et interbloqué
Sichere Reinigung: kippbare und verblockte Schlitten
Limpieza segura: plato volcador e interbloccado



Gruppo motore con trasmissione a cinghie
Belt driven motor assy
Groupe moteur avec transmission par courroie
Riemengetriebenemotorsatz
Sistema de motor con transmissiòn a correa

THE START FAMILY: MANUAL SLICERS

SUPER START

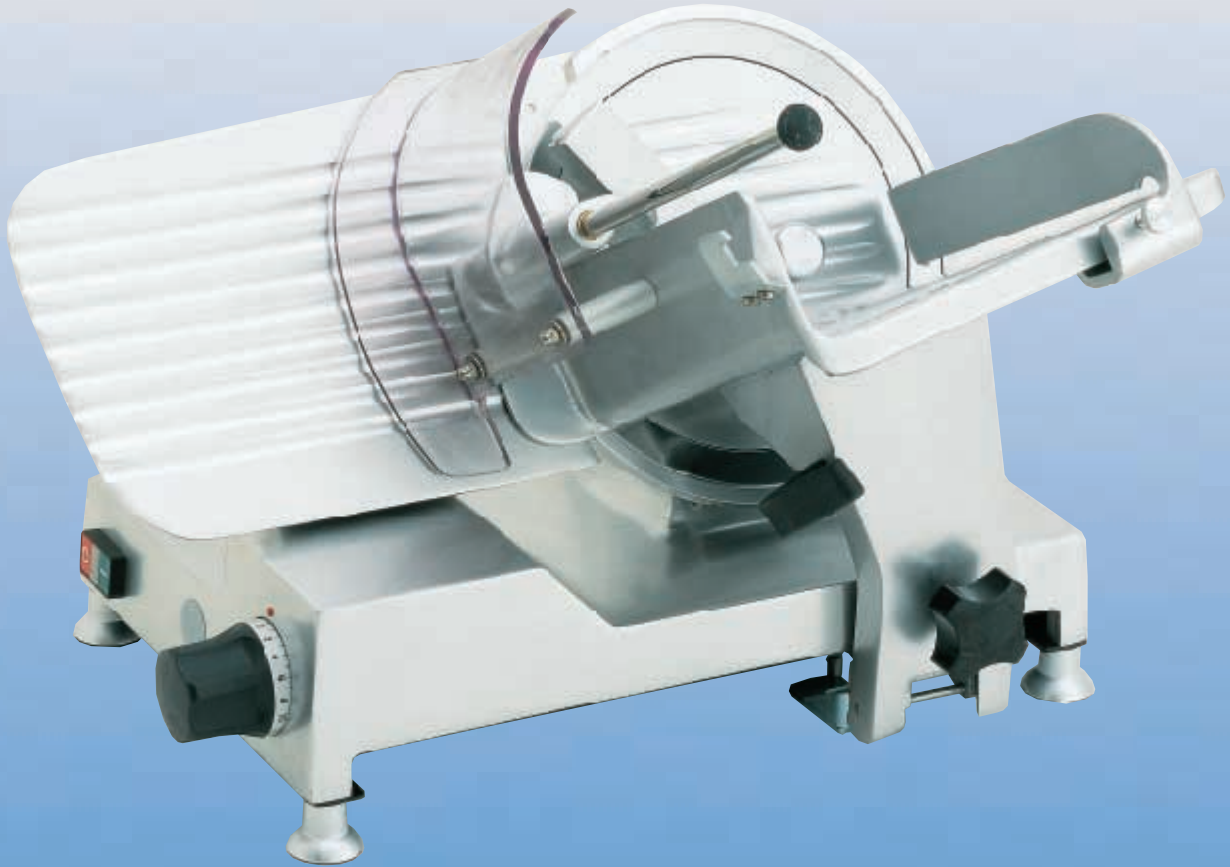

Super Start è un'affettatrice manuale con trasmissione a ingranaggi: è indicata per supermercati, grandi cucine.

Super Start is a gear driven manual slicer suitable for supermarkets, large catering installations.

Super Start est un trancheur manuel avec transmission à engrenages indiqué pour supermarchés et installations de grandes cuisines.

Super Start ist eine manuelle Aufschnitt-Schneidemaschine mit Zahnradantrieb geeignet für Supermärkte, Kantinen.

Super Start es una cortadora manual con transmisión a correa: la indicada para supermercados y grandes cocinas.



Protezione specifica contro l'umidità
Specific protection against moisture
Protection spécifique contre l'humidité
Spezifischer Feuchtigkeitsschutz
Protección específica contra la humedad



Pulizia veloce e sicura
Quick and safe cleaning
Nettoyage rapide et sûr
Schnelle und gefahrlose Reinigung
Limpieza rápida y segura



Gruppo motore con trasmissione a ingranaggi
Gear driven motor assy
Groupe moteur avec transmission à engrenages
Zahnradgetriebemotorsatz
Sistema de motor con transmisión a engranajes









THE START FAMILY: AUTOMATIC SLICERS

START AUTO SUPER START AUTO

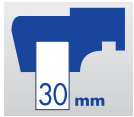
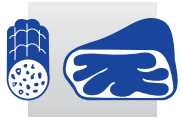

START AUTO: una compagna infaticabile di cui fidarsi – START AUTO: a tireless workmate to trust – START AUTO: une partenaire infatigable

THE START FAMILY

		START	SUPER START	START AUTO	SUPER START AUTO
Lama Blade Lame Messer Cuchilla		300 mm	300 mm	300 mm	300 mm
Potenza Power Puissance Leistung Potencia		0,30 Hp 0,22 Kw	0,30 Hp 0,22 Kw	0,55 Hp 0,41 Kw	0,55 Hp 0,41 Kw
Trasmissione Drive Transmission Antrieb Transmision		Cinghia Belt Courroie Riemen Correa	Ingranaggi Gear Engrenages Zahnrad Engranajes	Cinghia Belt Courroie Riemen Correa	Ingranaggi Gear Engrenages Zahnrad Engranajes
Struttura Structure Structure Aufbau Estructura		Peralluman	Peralluman	Peralluman	Peralluman
Motore ventilato Air-cooled motor Moteur ventilé Luftgekühlter Motor Motor ventilado		Yes	Yes	Yes	Yes
Peso netto Net weight Poids net Netto Gewicht Peso neto		29 Kg	33 Kg	43 Kg	45 Kg
Peso lordo Gross weight Poids brut Brutto Gewicht Peso bruto		34 Kg	38 Kg	48 Kg	50 Kg
Spessore di taglio Cut thickness Epaisseur de coupe Schnittstärke Espesor de la tajada		0 – 30 mm	0 – 30 mm	0 – 30 mm	0 – 30 mm
Capacità di taglio Cut capacity Capacité de coupe Schnittvermögen Capacidad de corte		250 x 210 mm	285 x 205 mm	285 x 205 mm	285 x 205 mm
Velocità variabile Variable speed Vitesse variable Verstellbare Geschwindigkeit Velocidad variable		No	No	0-40 slices/minute	0-40 slices/minute

OPTIONALS

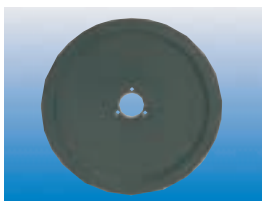

Lama per formaggio rivestita in teflon
Teflon coated blade for cheese
Lame à fromage en Teflon
Teflon-beschichtetes Messer für Käse
Cuchilla para queso cubierta en Teflon

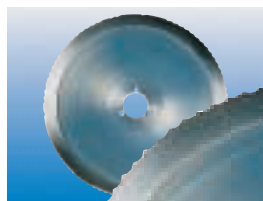

Lama per pane
Blade for bread cutting
Lame à pain
Brotmesser
Cuchilla para pan



Lama per carne congelata
Special blade for frozen meat
Lame pour viande congelée
Messer für tiefgekühltes Fleisch
Cuchilla para carne congelada



Tramoggia per taglio verdura
Chute for vegetable cutting
Glissière pour coupe des légumes
Rutsche fürs Schneiden von Gemüse
Tolva para el corte de vegetales

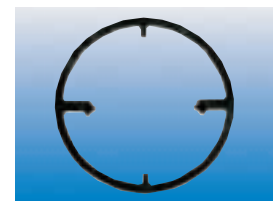

Estrattore lama
Blade extractor
Extracteur lame
Messerauszöher
Herramienta para extraer la cuchilla

THE START FAMILY

THE **START** FAMILY MANUAL SLICERS

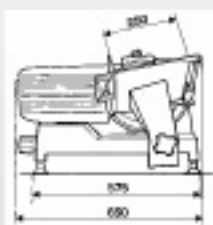

Start

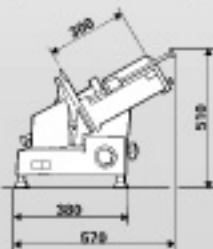
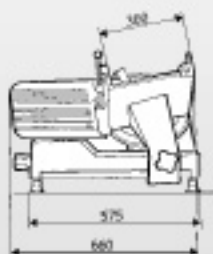

Super Start

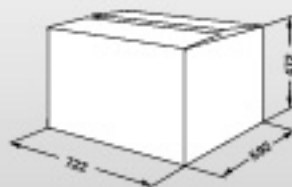

THE **START** FAMILY AUTOMATIC SLICERS

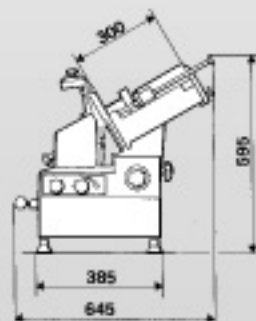
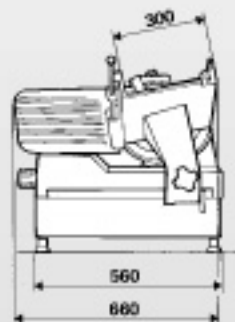

**Start Auto
Super Start Auto**

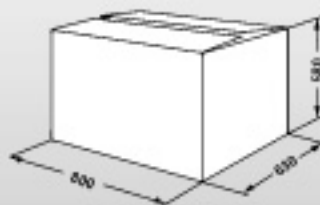

Le specifiche tecniche possono variare senza obbligo di preavviso - Specifications can be changed without notice - Les caractéristiques peuvent changer sans préavis - Technische Merkmale können geändert werden ohne vorherige Benachrichtigung - Las características pueden cambiar sin vínculo de preaviso

Centro vendita e assistenza
Distribution and service by
Vente et assistance par
Verkauf und Dienst von
Centro venta y asistencia